

PassTest

Bessere Qualität , bessere Dienstleistungen!



Q&A

<http://www.passtest.de>

Einjährige kostenlose Aktualisierung

Exam : **50-701**

Title : Foundations of Novell Open
Enterprise Server NetWare

Version : DEMO

1. Click the Exhibitbutton to begin.

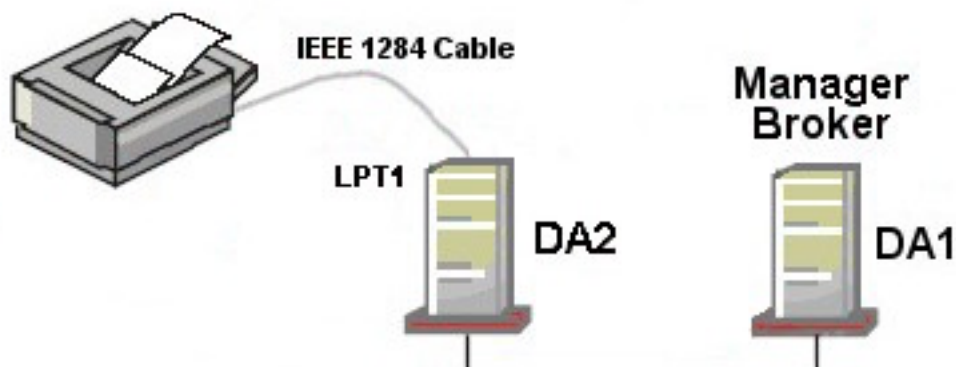

You need to configure a special purpose thermal-transfer printer for your organization. Because it doesn't have a built-in network interface, you've connected it to LPT1 on your DA2 server using a parallel cable. The Printer Agents for your organization's printers are managed by an iPrint Manager and Broker on your DA1 server.

You want to configure the iPrint Manager on DA1 to manage this new printer as well. Will this configuration work?

- A. Yes, all iPrint requirements have been met.
- B. No, iPrint isn't compatible with thermal printers.
- C. No, the Broker and the Manager can't reside on the same server.
- D. No, iPrint can't manage a printer connected to an LPT port on a server.
- E. No, locally-connected printers must have the Manager loaded on the local server.

Answer: E

2. Your company has four regional offices. You are the overall administrator for the entire organization. Each regional office has its own network administrator. You allow yourself and each regional administrator to use the Admin user object to manage the eDirectory tree. You have configured each user object to require unique passwords and to limit grace logins to 3. All user objects for temporary employees have an expiration date assigned to them. Do these policies conform to Novell's security recommendations.?

- A. Yes, all Novell security recommendations have been met.
- B. No, you shouldn't allow users objects to have grace logins.
- C. No, you shouldn't assign user accounts to temporary employees.

D. No, you shouldn't use multiple network administrators for the same tree.

E. No, each container administrator should have their own user object with specific rights assigned.

Answer: E

3. When installing OES NetWare, what is the minimum size for the server's DOS partition?

A. 50 MB

B. 100 MB

C. 200 MB

D. 300 MB

E. 500 MB

F. 750 MB

Answer: E

4. Click the Exhibit button to begin.

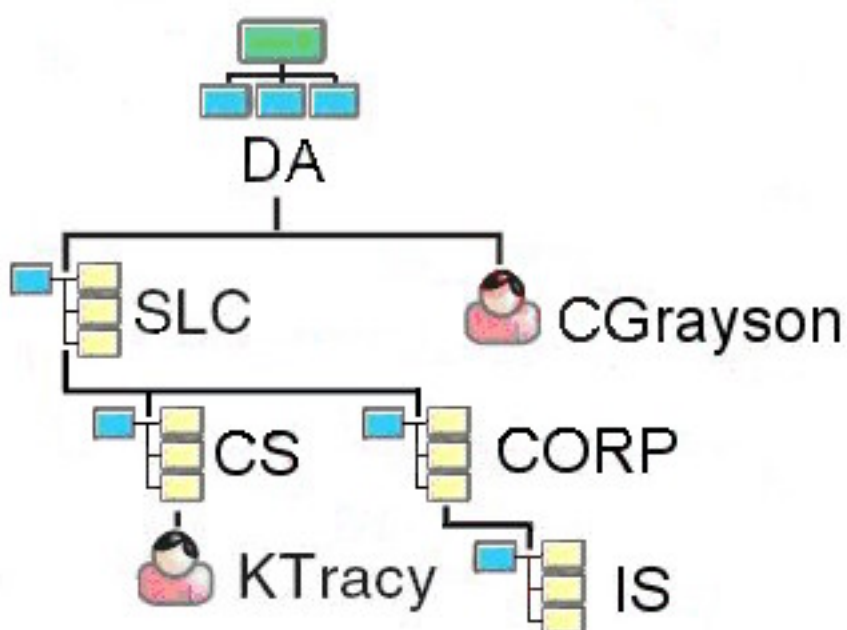

What is the context of the KTracy user object?

A. CS.DA

- B. SLC. DA
- C. CS.SLC. DA
- D. CORP.SLC. DA
- E. CORP.CS.SLC. DA

Answer: C

5. You're designing the eDirectory tree for your company. Your company is composed of four distinct subsidiary organizations. You decide to create four Organization objects at the root of your tree to represent each. Each subsidiary has its own Vice President who is in charge of the organization. You decide to create a user object for each Vice President in their respective Organization object. Will this design work?

- A. Yes, all eDirectory rules have been observed.
- B. No, user objects can't reside within an Organization object.
- C. No, Organization objects can only reside within Country objects.
- D. No, there can only be one Organization object within a given tree.
- E. No, Organization objects should not be used to represent subsidiaries. Organizational Unit objects should be used instead.

Answer: A

6. Which is the third file processed as the OES NetWare operating system boots?

- A. SERVER.EXE
- B. CONFIG.NCF
- C. STARTUP.NCF
- D. STARTUP.CFG
- E. AUTOEXEC. BAT
- F. AUTOEXEC. NCF

Answer: C

7. User NWadsworth has the ability to change passwords for users in the CORP.SLC.DA container in the DA-TREE. What should you check to identify where these rights are coming from? (Choose 3.)

- A. Rights granted to Public.
- B. Group objects NWadsworth is a member of.
- C. Alias objects associated with NWadsworth.
- D. Template objects associated with NWadsworth.
- E. Locality objects associated with NWadsworth.
- F. Objects that NWadsworth may be security equivalent to.

Answer: ABF





8. What properties are added to User objects when the eDirectory schema is extended to support iFolder?

(Choose 2.)

- A. iFolderQuota
- B. iFolderUserName
- C. iFolderPassword
- D. iFolderLDAPServer
- E. iFolderServerName
- F. iFolderHomeDirectory

Answer: AE

9. Click the Exhibit button to begin.

 KNOWLEDGE	Group Rights Granted	 Techs	[R F]
 EDIT	IRF	 Techs	[S ↓ ↓ ↓ ↓ ↓ F ↓]
	User Rights Granted	 DCoughanour	[RW M A]

The user object DCoughanour is a member of the Techs group. This group has been assigned Read and

File Scan file system rights to the KNOWLEDGE folder. EDIT is a subdirectory of KNOWLEDGE that contains support files that are waiting to be edited before being published. An IRF has been placed on this directory that blocks all rights except for the Supervisor and File Scan rights. User DCoughanour needs access to these files that will allow him to edit them. His object has an explicit rights assignment to EDIT for the Read, Write, Modify, and Access Control rights. What are DCoughanour's effective rights to the contents of the EDIT directory?

- A. Supervisor
- B. Read, File Scan
- C. Create, Erase
- D. Read, Modify, File Scan
- E. Read, Write, File Scan
- F. Read, Write, Modify, Access Control
- G. Read, Write, Modify, File Scan, Access Control
- H. Read, Write, Create, Erase, Modify, File Scan, Access Control
- I. This object has no rights to the EDIT directory.

Answer: G

10. Which directories does Novell recommend you implement to organize your NetWare server's file system? (Choose 3.)

- A. Shared directories.
- B. ZENworks profile directories.
- C. iFolder data directories on SYS.
- D. An iPrint spooling directory on SYS.
- E. User home directories on a volume other than SYS.
- F. A directory named ETC in each user's home directory for configuration files.

Answer: ABE

11. Which versions of NetWare support the IP protocol? (Choose 2.)

- A. OES NetWare
- B. NetWare 3.1

- C. NetWare 5.1
- D. NetWare 4.2
- E. NetWare 4.0
- F. NetWare 4.11

Answer: AC

12. Which Open Source services are supported by OES NetWare? (Choose 2.)

- A. KDE
- B. MySQL
- C. named
- D. Emacs
- E. Pure-FTP
- F. Apache Web Server

Answer: BF

13. The _____ product, included with OES NetWare, allows users to search for names, addresses, and phone numbers stored in eDirectory.

Answer: eGuide

14. Which OES NetWare product provides high availability of critical network resources?

- A. MySQL
- B. Rsync
- C. iPrint
- D. eGuide
- E. File Versioning
- F. Novell Cluster Services
- G. Web Application Services

Answer: F

15. Which operating systems are supported by OES services? (Choose 2.)

- A. NetWare 6.5
- B. NetWare 5.1
- C. Windows Server 2003
- D. SUSE Linux Enterprise Server
- E. Red Hat Enterprise Linux Server

Answer: AD

16. You are planning to deploy Novell Open Enterprise Server services on an existing NetWare 6.5 server. Which Support Pack must be installed on the server before you can do this?

- A. NetWare 6.5 Support Pack 1
- B. NetWare 6.5 Support Pack 1a
- C. NetWare 6.5 Support Pack 2
- D. NetWare 6.5 Support Pack 3

Answer: D

17. Which types of scripts can be used to manage an OES NetWare server from the server console?
(Choose 2.)

- A. OpenScript
- B. JavaScript
- C. Perl scripts
- D. UnrealScript
- E. bash shell scripts

Answer: CE

18. Which of the following are advantages of using Novell OES? (Choose 2.)

- A. Use of familiar NetWare services on Linux.
- B. Interoperability with Windows servers and clients.
- C. Use of familiar NetWare services on Windows servers.
- D. The ability to run Linux daemons on the NetWare platform.
- E. The ability to run Windows programs on the Linux platform.

Answer: AB

19. You need to create a new user object in your eDirectory tree using the ConsoleOne management utility. You don't have ConsoleOne installed on your local Windows workstation, so you must run it from your OES NetWare server. Where should you look in the server's file system for the ConsoleOne.exe executable?

- A. Sys:\Public\bin
- B. Sys:\Public\Win32\ConsoleOne
- C. Sys:\Public\Mgmt\ConsoleOne\1.2\bin
- D. Sys:\Public\WINNT\ConsoleOne\1.2\bin

Answer: C

20. You need to access iManager on an OES NetWare server that has been assigned an IP address of 10.200.200.3. Which URL should you use?

- A. <https://10.200.200.3:8009>
- B. <http://10.200.200.3:8008/nds>
- C. <https://10.200.200.3/nps/iManager.html>
- D. <http://10.200.200.3:8008/nps/iManager.html>
- E. <https://10.200.200.3:8009/nps/iManager.html>

Answer: C